

Design Data

Rated Flow (gpm)	30	Proj. Effective Area (sq. ft.)	85
Flash Volume (gal.)	25	Floc Volume (gal.)	70
Hopper Volume (gal.)	100	Shipping Weight (lbs.)	2800
Plate Spacing (inch)	2	Operating Weight (lbs.)	7500

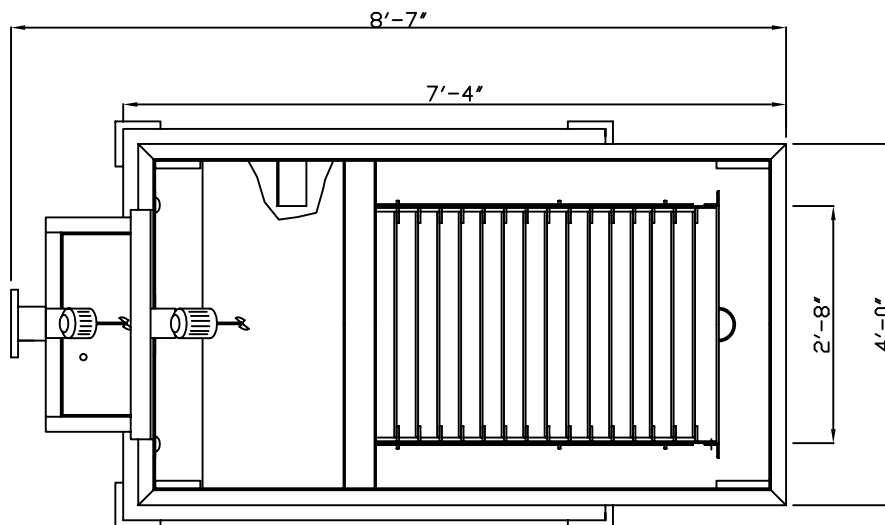

PLAN VIEW

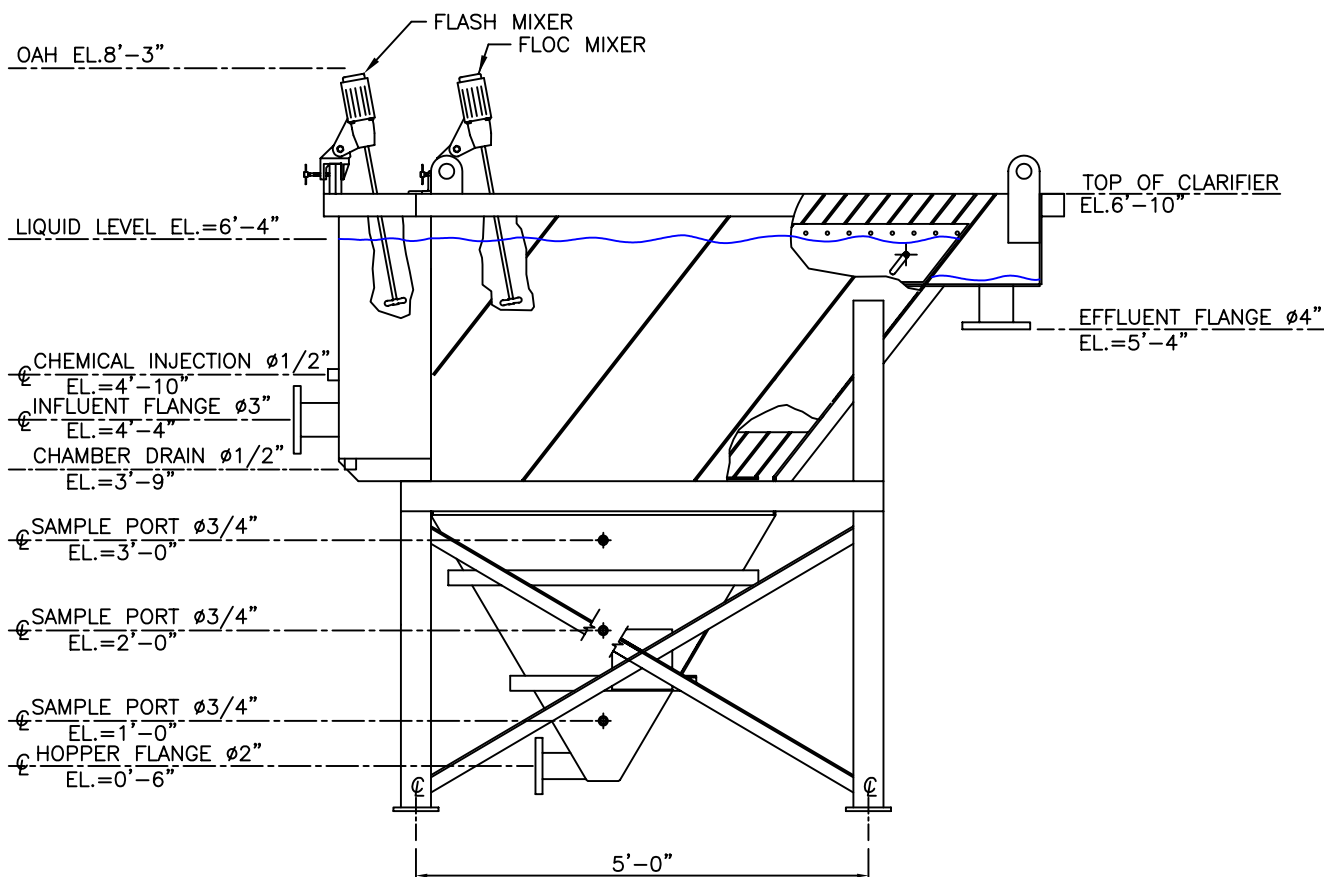

SIDE ELEVATION



-CONFIDENTIAL-

NOT TO BE DISCLOSED, USED OR DUPLICATED
EXCEPT AS AUTHORIZED IN WRITING BY UNIPURE

TITLE:

UniPure 30-85-G2 Clarifier
Design Data

DWG No.

C30DD